



ULTRA SLIM

Aluminium Frame Swing Door USS60





“Elevate Your Interior with our Ultra-Slim Aluminium Frame Swing Door”

ULTRA-SLIM FRAME

With its slim profile measuring just 12mm, the Ultra-Slim Aluminium frame in Matte Black on the ESTRON USS60 creates a modern and stylish aesthetic. This sleek design seems to almost disappear, directing attention to the elegant glass panels and the surrounding architecture. The Matte Black finish demonstrates an air of sophistication, elevating the overall look.

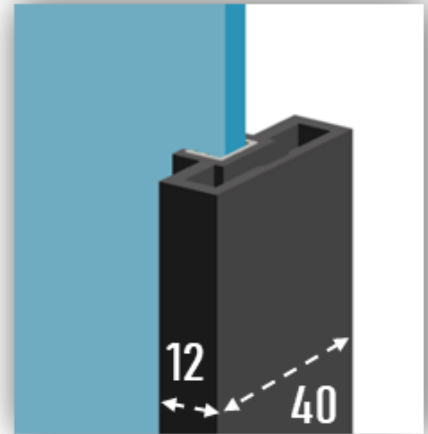

ADJUSTABLE & EASE INSTALLATION

The door mechanism is highly adjustable and can be modified in terms of height, width as well as left-to-right alignment. This level of adjustability allows for the system to cater to all, ensuring that the door operates smoothly. The top and bottom free pivot of this swing door can be easily installed and no wall hinges are required, making installation straightforward and hassle-free.

APPLICATIONS

ESTRON USS60 conveniently available as a complete set. An ideal choice for residential interior applications such as room separation, room entry and closet doors. Its functionality and design cater to the needs of homeowners looking for stylish and efficient solutions for dividing or accessing different spaces within their homes.



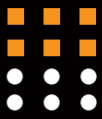

ULTRA SLIM ALUMINIUM FRAME SWING DOOR USS60

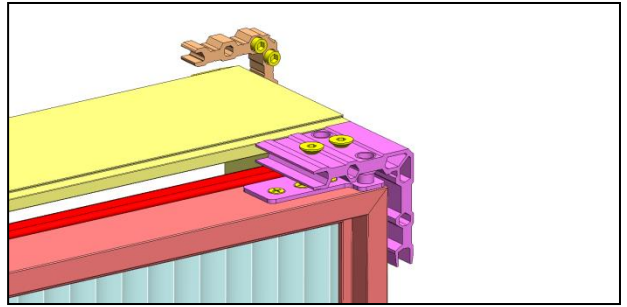
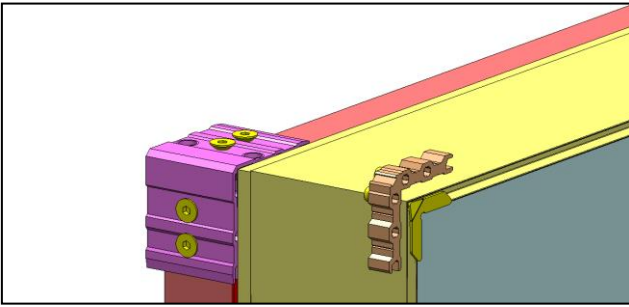

TECHNICAL SPECIFICATIONS

S/N	Description	Specifications
		USS60
1	Panel Configuration	1 Swing Door
2	Finishing	Matte Black
3	Max. Door Width & Height	1000mm x 2650mm
4	Max. Door Weight	60kg
5	Door Configuration	8mm glass (Framed)
6	Frame Dimension	Ultra-Slim 12mm (Frontal View) x 40mm (Profile View)
7	Adjustment Modes	Top & Bottom Free Pivot

COMPONENT LIST







USS60 system for 1 swing door includes:

Top & Bottom Free Pivot with Frame Bracket & Screw Set, 1 box

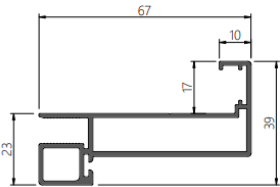
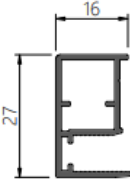
1. Top & Bottom free pivot, 4 nos
2. Inner frame bracket, 2 nos
3. Glass door bracket, 4 nos
4. Screw set

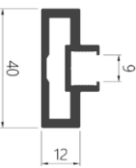

COMPONENT LIST

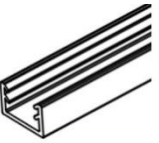
 <p>1. USS60-3967 Inner Wall Frame 39 x 67mm (5.4m/ pc) (Matte Black), 1 pc Require: 1.2 pcs/ Door</p>	 <p>2. USS60-2716 Outer Wall Frame 27 x 16mm (5.4m/ pc) (Matte Black), 1 pc Require: 1.2 pcs/ Door</p>	 <p>3. USS60-9508 Aluminium sheet for wall adjust (5.4m/ pc) (Matte Black), 1 pc Require: 1.2 pcs/ Door</p>
 <p>4. STC80-4018 Stiles Door Frame 40 x 18mm (4.9m/ pc) (Matte Black), 1pc Require: 1.5 pcs/ Door</p>	 <p>5. USS60-B1 Angle Bracket for USS60-3967, 1pc Dimensions: 11.8 x 1.2 x 1.8mm</p>	 <p>6. USS60-B2 Angle Bracket for USS60-2716, 1pc Dimensions: 7.0 x 1.2 x 1.9mm</p>
 <p>7. USS60-B3 Corner Bracket for USS60-2716, 1 pc Dimensions: 11.6 x 9mm</p>	 <p>8. USS60-WP Rubber Sealing Strip for Door Frame USS (147m/ roll) Require: 7m/ Door</p>	 <p>9. STC80-U825 8mm White "U" Clip Seal (2.5m / pc) Require: 3pcs/ Door</p>



1. USS60-PL1
Magnet Lever Handle come with
One side Key & One Side Thumb
Turn (Matte Black), 1 set



TECHNICAL DRAWINGS

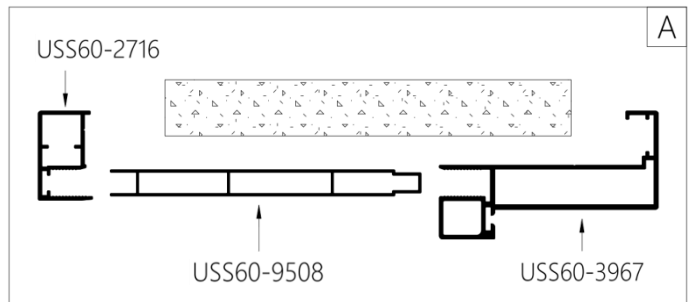
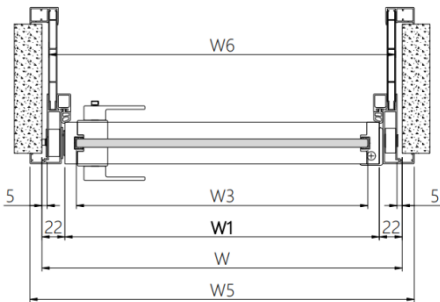
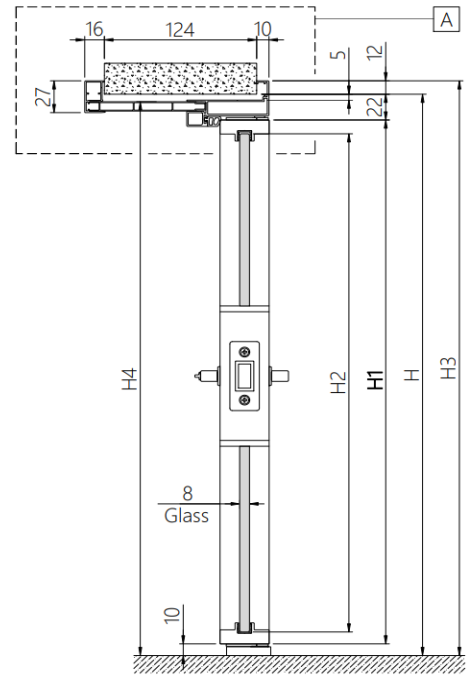
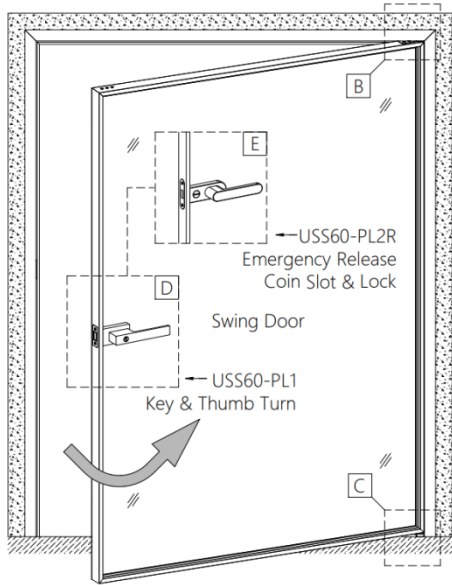

Code	Description	Formula
W1	Swing Door Width (Top/Bottom Rail Width)	Given Dimensions
H1	Swing Door Height	
W	Wall to Wall Opening Width	$W1 + (40 \sim 44)$
H	Floor to Opening Height	$H1 + (30 \sim 32)$
W3	Infilled Glass Panel Width	$W1 - 22$
H2	Infilled Glass Panel Height	$H1 - 22$
W5	Swing Door Frame Width	$W1 + 67$
H3	Swing Door Frame Height	$H1 + 44$
W6	USS60-9508 Width	$W5 - 36$
H4	USS60-9508 Height	$H3 - 18$
Swing Door		W1 x H1
Swing Door Glass		W3 x H2

