

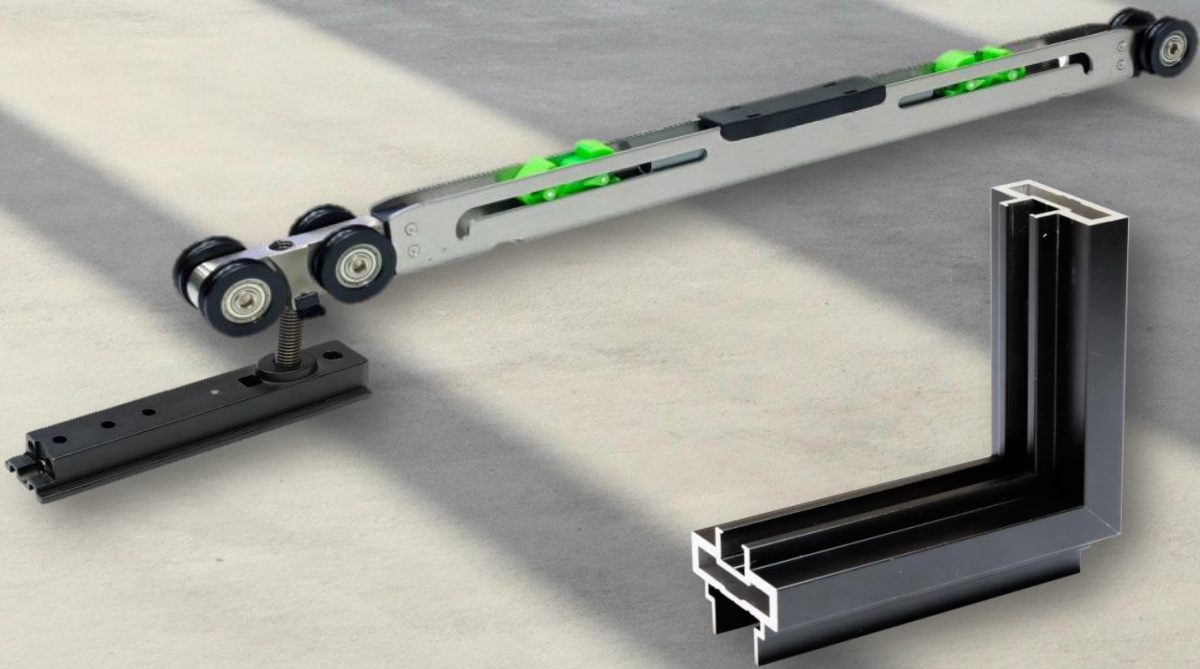

ESTRONTM

ESTRON MARKETING PTE. LTD.



STC80-1S SOFT CLOSE SLIDING DOOR WITH ULTRA SLIM FRAMED



“Experience modern design with Ultra Slim Framed with Soft Closing features”

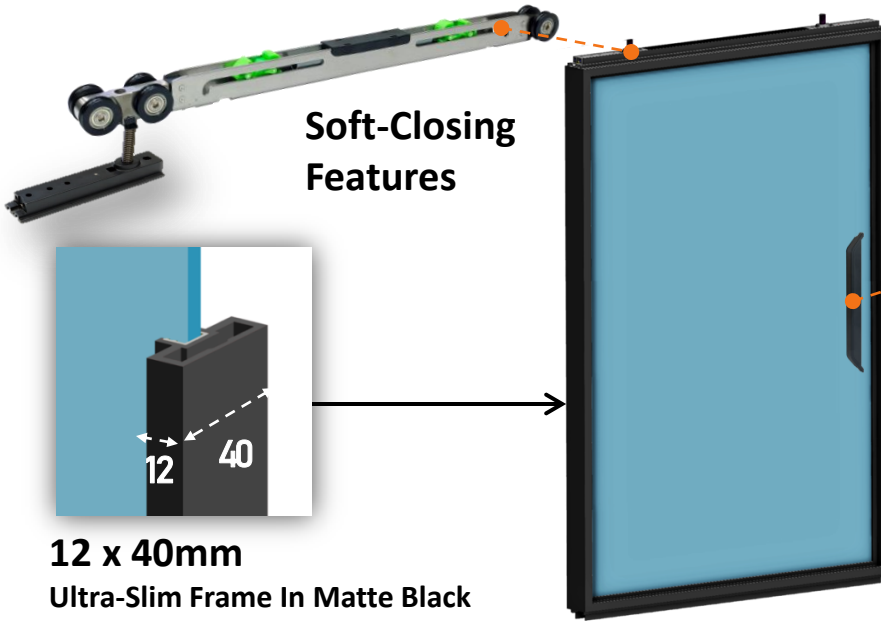

Soft-Closing Features

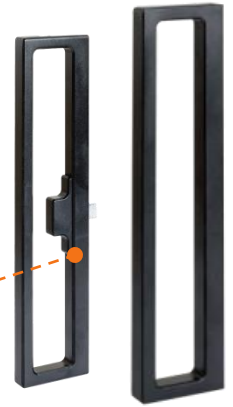

Complementing Sliding Handle In Matte Black

- Estron **STC80-1S** Soft Closing Sliding Door with Ultra Slim Framed can accommodate up to an impressive **80kg** / panel in **8mm** glass thickness.
- **One-way** and **Two-way** soft closing.
- Upgrade your entrance and doors with ease.
- Perfect for residential interior applications such as kitchens, offices, and more.

TECHNICAL SPECIFICATIONS

S/N	Description	Item Code	
1	Panel Configuration	STC80-1S	
2	Track Length	3.0 m	
3	Finishing	Matte Black	
4	Door Width	425-1200mm	470-1200mm
5	Soft Closing	One-way Soft Closing	Two-way Soft Closing
6	Max. Door Weight	80kg	
7	Door Configuration	8mm glass (Framed)	

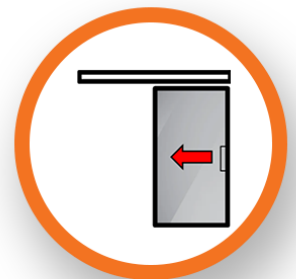





COMPONENT LIST

STC80-1S system for 1 sliding panel includes:

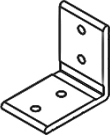
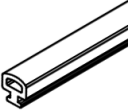
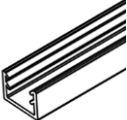
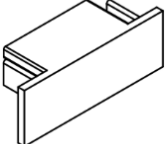
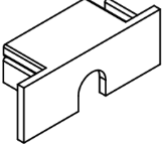
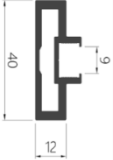
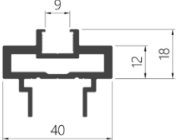
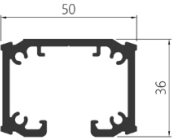

1. Soft Closing Barrier Carrier, 1nos
2. Latch Activator, 2nos
3. Carriage Roller, 3nos
4. Hanging Bracket, 2nos
5. Floor Guide, 1nos

 <p>1. STC80-MB Aluminium Frame Corner Bracket. N/A Finish. Require: 4pcs / Door Frame</p>	 <p>2. STC80-WP060 Rubber Sealing Strip for STC80-4818 Require: 5.0m x (no. of door frame - 1)</p>	 <p>3. STC80-U825 8mm White "U" Clip Seal, 2.5m/pc Require: 3pcs / Door Frame</p>
 <p>4. STC80-EC2 Top Rail End Cap Black Require: 2pcs / Door Frame</p>	 <p>5. STC80-EC3 Bottom Rail End Cap Black Require: 2pcs / Door Frame</p>	 <p>6. STC80-4018 40mm x 18mm Stiles Frame Matte Black</p>
 <p>7. STC80-4032 40mm x 18mm Top & Bottom Door Rail Matte Black Require: 2pcs / Door Frame (Max. width 1.2m / pc)</p>	 <p>8. STC80-3650 36mm x 50mm Single Channel Top Track Black</p>	 <p>9. STC80-AC78 Aluminium Cover for Top Track Matte Black</p>



ADDITIONAL COMPONENTS

 <p>1. STC80-PH1 Flush Handle, Matte Black Length: 220mm (L), 1 pair</p>	 <p>2. STC80-PH2 Pull Handle, Matte Black Length: 220mm (L), 1 pair</p>	 <p>3. STC80-PH-2L Pull Handle w/ Lock Matte Black & Wall Strike Plate, Length: 220mm (L), 1 pair</p>	 <p>4. STC80-FP Optional Fix Panel Accessories For : STC80-2S/3S Require: 1 set / Fixed Panel</p>
--	---	---	--

TECHNICAL DRAWINGS

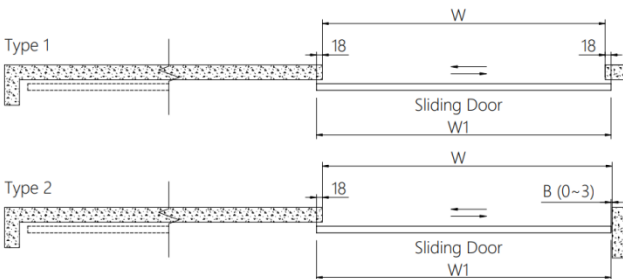
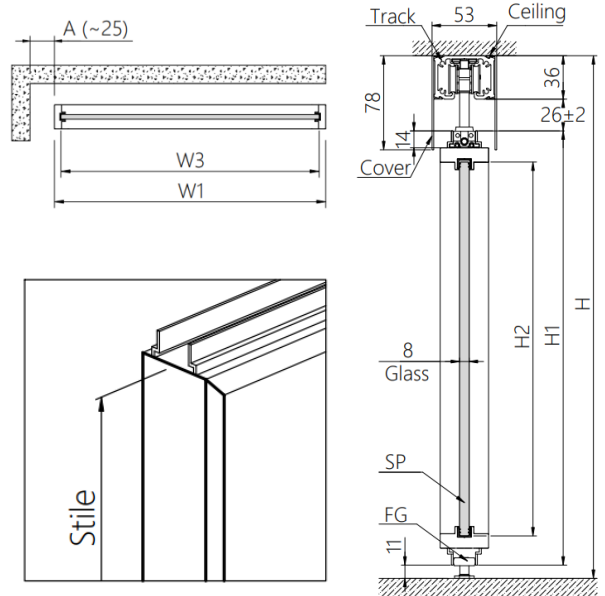
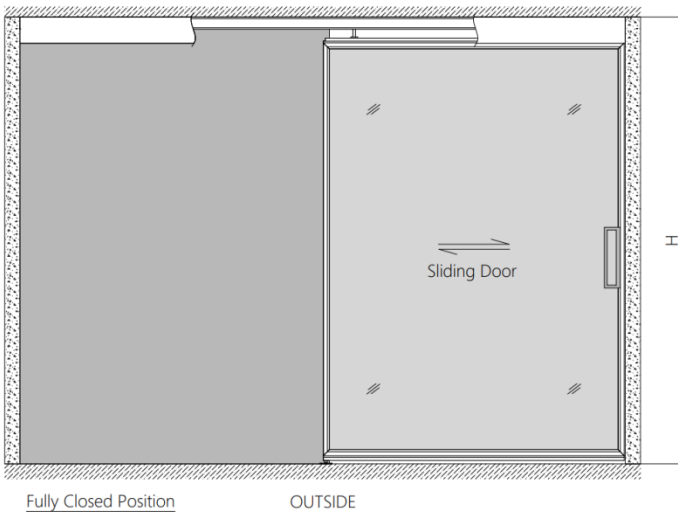

Code	Description	Formula
W	Wall to Wall Opening Width	Opening Dimensions W x H
H	Floor to Ceiling Height	
W1	Sliding Door Top/Bottom Rail Width	$W + 36 / W + 18 - B(0 \sim 3^*)$
W3	Sliding Door Glass Width	$W1 - 22$
H1	Sliding Door Height	$H - 73$
H2	Sliding Door Glass Height	$H - 123$
	Sliding Door	$W1 \times H1$
	Sliding Door Glass	$W3 \times H2$
	Stile Height	$H1 - 28$