



**ESTRON**<sup>TM</sup>

**ESTRON MARKETING PTE. LTD.**



# **PIVOT DOOR SYSTEM**

**Quality Architectural  
Hardware Specialist**



# PD SERIES PIVOT DOOR SYSTEM

## FEATURES

- Suitable for frameless swing glass door up to 12mm thickness
- Glass preparation is required
- Material: 304 Stainless Steel
- Finish: Satin (SSS)



**PD-10**  
(Bottom Pivot)

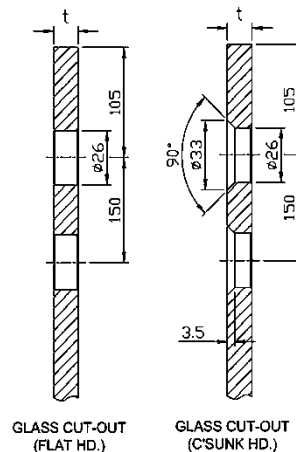
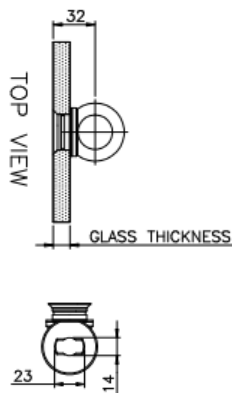
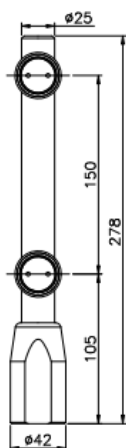

**PD-20**  
(Top Pivot)

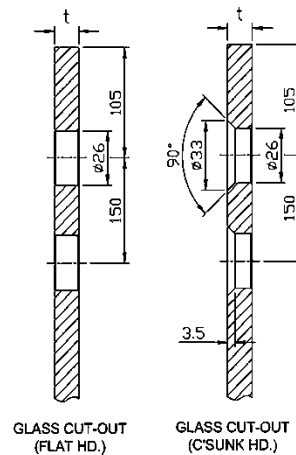
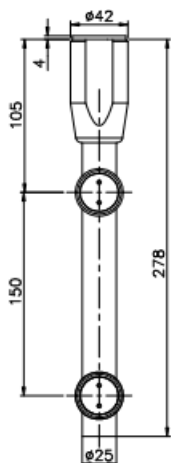

**PD-30**

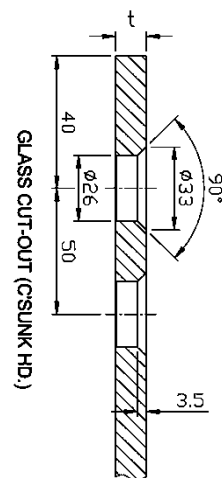
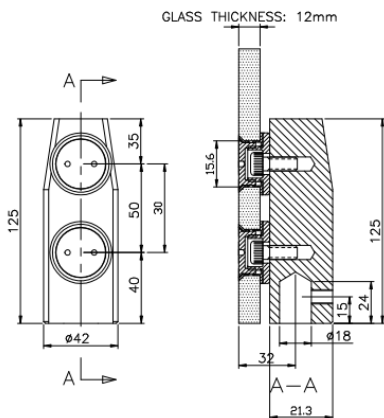



## GLASS PANEL ELEVATION & CROSS SECTION

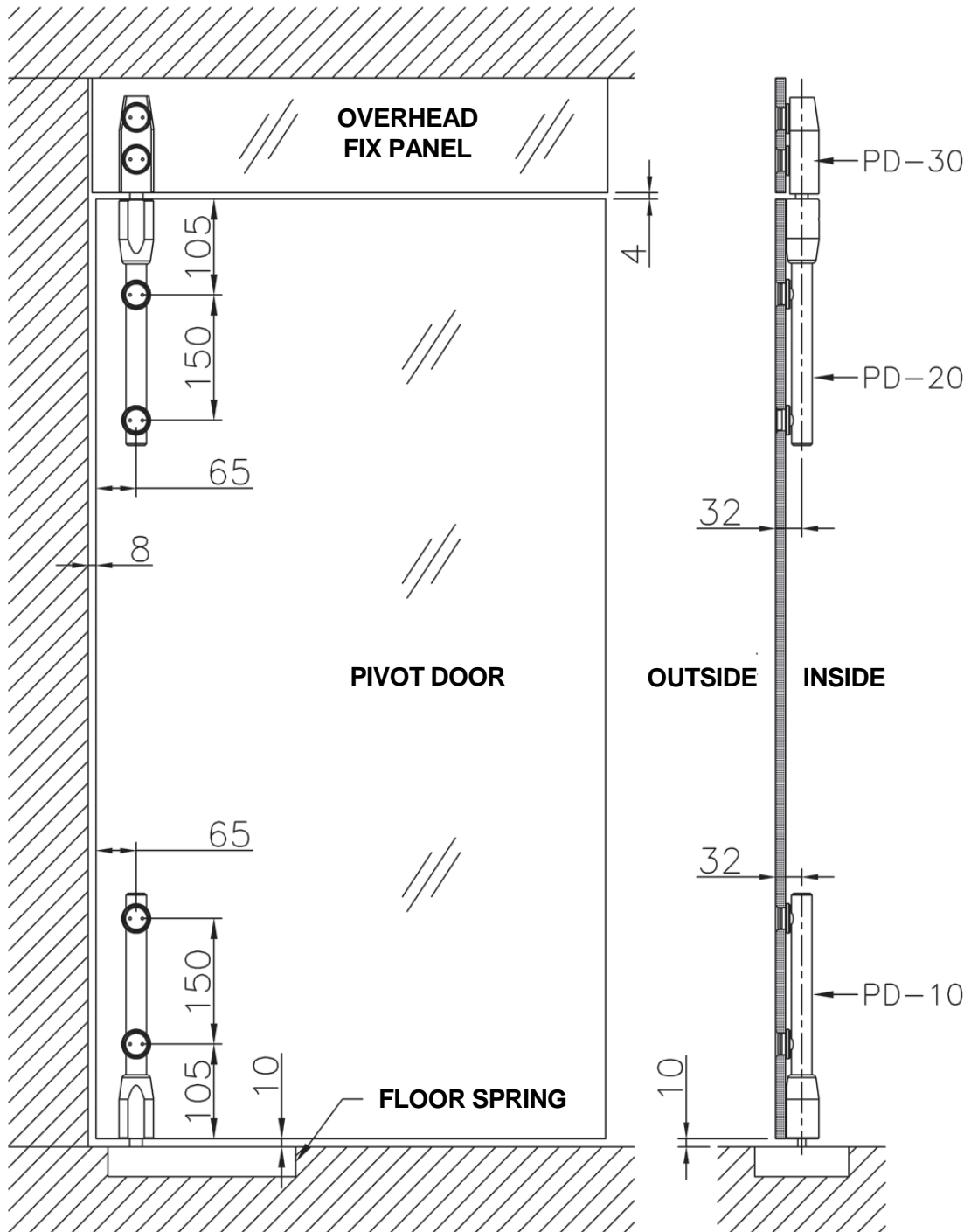



**Estron Marketing Pte. Ltd.**

141 Woodlands Industrial Park E5 E-terrace Singapore 757507

tel. +65 6853 9041 fax. +65 6853 9042

e-mail. sales@estron.com.sg url. www.estron.com.sg



*Product improvement is a continuous process,  
please check specifications at point of purchase.*