

Glass To Wall

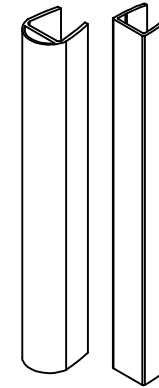

LSS-8C/U  
LSS-10C/U  
LSS-12C/U

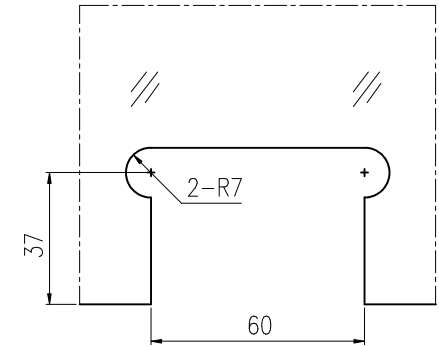

GLASS PREPARATION

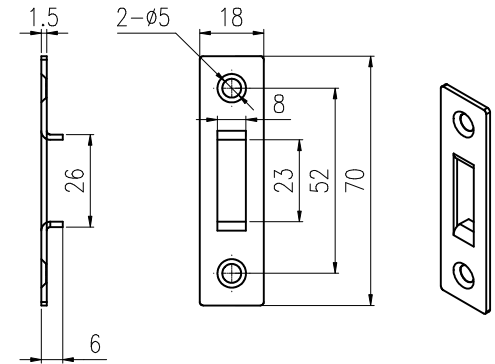
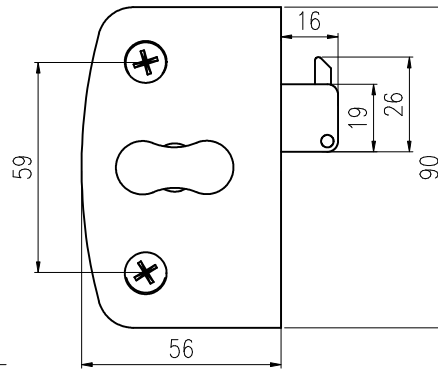
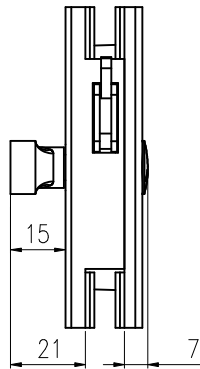
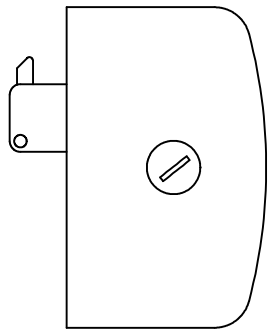
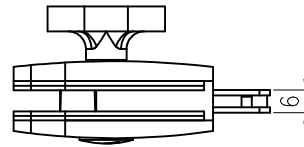

Wall Plate

Suitable For 8-12mm Thick Glass  
\*If bumper seal is applied, LSS-8/10/12 C/U is recommended.



**ESTRON MARKETING PTE. LTD.**  
141, Woodlands Industrial Park E5  
E-Terrace, Singapore 757507.  
Tel: +65 6853 9041  
Fax: +65 6853 9042  
Email: sales@estrone.com.sg

**PROPRIETARY AND CONFIDENTIAL**

CONSTANT PRODUCT DEVELOPMENT AND ENHANCEMENT IS OUR COMPANY POLICY, THEREFORE SPECIFICATIONS AND DETAILS CONTAINED IN THIS DRAWING MAY BE ALTERED WITHOUT PRIOR NOTICE. THIS DRAWING IS THE SOLE PROPERTY OF ESTRON MARKETING PTE LTD, WITHOUT WRITTEN CONSENT; REPRODUCTION AND DISSEMINATION OF ANY PARTS OF THIS DRAWING IS STRICTLY PROHIBITED.

PROJECTION:

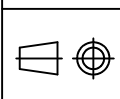

UNITS:

MM

TITLE:

SCALE: N.T.S  
DATE: 01/07/2015

DWG. No.:

PROJ No.:

SL-407H

SL-407H  
-